

OPTIONS 2024

Advice for families



During the Spring term, Year 9 pupils will choose the option subjects they wish to study at KS4. Ideally, these choices should be a reflection of the abilities and interests of each pupil.

Throughout this booklet, we have discussed all the different factors that should be considered.

Some pupils already know which career they wish to follow and will find that the requirements coincide with the subjects they enjoy the most and in which they are progressing well.

However, some pupils will change their minds and many, at the moment, do not know which career they wish to follow.

Therefore, it is important that the choice of subjects is well balanced, thus leaving as many doors open as possible.

We hope that you will find this booklet useful in helping you with the options process. I look forward to meeting you in school at the **Information Evening on Tuesday 16th January** and at **Progress Evening on Thursday 1st February**.

Matt Holden
Deputy Headteacher

What subjects can I choose?

Some subjects remain compulsory:

- Religious Education
- Mathematics
- English
- Science
- Core PE (1 hour per week)

Pupils will be able to choose 3 additional GCSEs or vocational alternatives.

If in doubt about the subject combinations required by Post-16 or Higher Education providers, please consult the relevant websites or contact them directly to seek advice. The UCAS website provides details of university entrance requirements for each course.

Support from school

Option Talks

Subject staff are speaking to pupils in their timetabled lessons to support their option choices this year.

Option Information Evening for Parents, Carers and Pupils

A meeting for Year 9 parents, carers and pupils, to explain the options programme in more detail, will be held on Tuesday 16th January 2024 at 6.30pm.

Year 9 Progress Evening

There will also be an opportunity for parents to speak with teachers at the Year 9 Progress Meeting on Thursday 1st February 2024 to discuss progress and options.

Deadline for completed online options forms will be Friday February 9th 2024. Pupils will be informed of their final option allocations in June/July.

What if a course is oversubscribed?

We are proud of the fact that we are able to offer a wide selection of courses each year. However, on occasions, it may be necessary to review the subjects on offer during the selection process.

Although we will do our best to offer pupils their preferred subjects, occasionally, due to staffing constraints and the availability of facilities, it is not always possible to do so. If, for example, not enough pupils choose a subject, then it will be withdrawn. Conversely, if a subject is oversubscribed, we will do our best to offer an additional group but there may be occasions when this is not possible.

If a number of subjects become oversubscribed and it is not possible to offer additional groups, in the interest of fairness, pupils who wish to study a number of oversubscribed subjects may in fact only be offered one of them.

How will subjects be graded?

GCSE Grades

GCSE subjects are graded as 9 - 1, with 9 being the highest grade.

Vocational Courses

Level 1/2 vocational courses will be graded as:

D2* > D2 > M2 > P2

D1 > M1 > P1 > U

The **approximate** equivalencies of the new GCSEs to the old GCSEs and vocational alternatives are indicated below.

	Level 2						Level 1			
New GCSE	9	8	7	6	5	4	3	2	1	U
Old GCSE		A*	A	B	B/C	C	D	E	F/G	U
Vocational		D2*	D2		M2	P2	D1	M1	P1	U

KS4 Option Choices

GCSE Courses

- Art, Craft & Design
- Computer Science
- Design & Technology
- Drama
- Food & Nutrition
- French
- Geography
- Graphic Communications
- History
- Music
- Photography
- Physical Education
- Spanish
- Triple Science

Level 1/2

Vocational Courses

- BTEC Health & Social Care
- Cambridge Nationals Creative iMedia
- Cambridge National Sports Studies
- Cambridge Nationals Engineering Design
- Cambridge Nationals Engineering Programmable Systems

Level 1

Vocational Courses

- Asdan Personal Development Programme

Factors to Consider

Q1: Are you good at a subject ?

A1 : Ability in a subject is a solid foundation upon which to base future studies especially to examination level.

Q2 : Do you like the subject ?

A2: Enjoyment and interest in a subject are a big help when studying. However, do consider why you like a subject. Is it because you like the teacher ? If so it may well be that the same teacher will not be teaching you in Years 10 and 11.

Q3: Do you know the demands of the subject ?

A3 : Find out all about the subject before you choose. Does the subject require a high level of practical skill or is it likely that there will be a greater amount of theory content ? How is the course assessed? Ask the subject teacher if you want more information.

Q4: Are you willing to work hard in class and make the necessary effort with home learning?

A4 : This is vital for all subjects if you are to be successful.

Q5 : Would the subject be useful for a future career ?

A5: If you want advice regarding possible careers, consult the relevant websites which are referred to on page 5 of this booklet or ask staff for advice.

Q6 : Is a certain combination of subjects possible?

A6 : If in doubt, ask Mrs Munro or Mr Holden

Q7: Is it foolish to choose a subject because a friend has chosen it ?

A7 : YES - so don't do it! You are very likely to be in different classes with different teachers anyway.

Careers Advice

Careers support is offered in a number of ways:

- Careers lessons as part of the PSHE programme.
- Assistance in making Year 9 subject choices through timetabled options sessions.
- Targeted one to one sessions for Years 10 & 11 with Mrs Gaskill.
- Year 10 pupils will have the opportunity of a virtual work experience later in the summer term.
- Opportunities to attend the Ribble Valley Careers Events will be available.
- Year 11 pupils will receive an additional individual careers appointment to discuss opportunities available to them.
- Various careers based activities during annual careers week (all years , 22nd—26th Jan 2024)
- College application support - lunchtime drop in with post 16 providers (Year 11)
- Year 11 Mock Interviews
- Careers education within the curriculum and PSHE lessons.

Useful Websites

www.ucas.com

www.apprenticeships.gov.uk

www.nationalcareers.service.gov.uk

www.notgoingtouni.co.uk

www.russellgroup.ac.uk

www.training2000.co.uk

www.nltg.co.uk

www.barclayslifeskills.com

www.gov.uk/browse/education

www.bbc.co.uk/bitesize/careers

www.whystudylanguages.ac.uk

www.tomorrowseengineers.org.uk

www.mathscareers.org.uk

www.brightknowledge.org

www.icould.com

www.careerpilot.org.uk

www.prospects.ac.uk

GCSE Art, Craft & Design



Visit to Tate Gallery

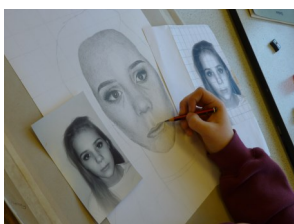

During the course pupils will have opportunities to visit art exhibitions, take part in workshops with artists and develop their ICT skills. In the past we have taken our GCSE students to the Tate Gallery in Liverpool, Manchester City Art Gallery and the 'Clothes Show Live.' Pupils opting for this course will also be required to make independent visits to gallery exhibitions.



Art Workshop - Working with visiting Artists

Pupils are required to develop the knowledge, skills and understanding through integrated critical, practical and theoretical study of Art, Craft and Design which includes first-hand experience of original work.

Pupils will be required to demonstrate **techniques** and throughout the two year course pupils will be introduced to a variety of experiences, exploring a range of other media, processes and techniques:

*Drawing *Painting *Mixed media *Photography *Collage
*3 dimensional work *Print making *Computer generated imagery

They may explore overlapping **themes** and a combination of areas.

Pupils will respond to two or more different themed portfolio coursework units during the year 10 and 11 course, for example: Landscape/Natural Forms, Figure/Portraits, Culture/ Identity.

EQUIPMENT: Pupils will need to purchase the following items in Year 10: Sketchbooks A3/A4/A5, A2 portfolio or folder, sketching / shading pencils (full range) and colouring pencils, glue stick, watercolour paints and paintbrushes / oil pastels. Please enquire if you need support with this. A pack can be purchased in September

Pupils cannot be entered for GCSE Art, Craft & Design and GCSE Graphic Communication. It is highly recommended that pupils selecting Photography do not choose Art also.

How will I be assessed?

Component 1: Portfolio 60% (You will need an A2 Folder)

This will show coverage of the four assessment objectives . It must include a project and a selection of further work undertaken during the pupil's course of study.

Component 2: Externally set assignment 40% given by AQA exam board

Pupils will select a title and then after preparatory time they will have 10 hours of supervised time in which to develop their work.

Pupils will submit all of their work at the end of the two year course. There is an important emphasis on **Drawing and Written work**. Pupils **must** provide thorough evidence of drawing and written work in both their **Unit 1** portfolio and their externally set assignment—**Unit 2**.

Post-16 Opportunities

Art, Craft and Design is a challenging but very rewarding GCSE subject; it allows pupils to develop **excellent research skills** and encourages them to communicate their ideas, feelings and experiences through visual outcomes.

Many of our pupils progress through to Fine Art AS and A2 level, Photography, Graphics, Textiles Art and Fashion and other Visual Art Courses. It can also provide excellent groundwork for entry to higher education and degree level careers.

Careers:

Art director / Architect / Interior Designer / Fashion / Graphics / Web Designer, Illustrator, Photographer, Art and Design Teacher, Fine Artist, Hairdresser, Architect, Floristry, Teacher, Advertising. Students also have opportunities to go to careers talks in school, at colleges and at Galleries or work with visiting artists.

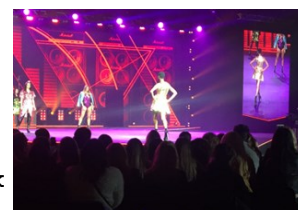

GCSE Computer Science

This new, up-to-date qualification reflects the fast changing world of Computer Science. Help students develop the computational skills they need for an exciting digital future beyond the classroom with:

- an exciting, practical focus on real-life programming, developing skills relevant to the future
- innovative, practical, future-looking onscreen assessments

Computer science can be a challenging subject and requires a lot of problem-solving and analytical skills. You will need to have a good grasp of mathematics, as well as an ability to think logically and methodically.

Pearson Edexcel Computer Science is divided into **six topics**:

*Computational thinking *Data *Computers *Networks
*Issues and impact *Problem solving and programming



How will I be assessed?

The assessment consists of two equally weighted, non-tiered components – one theory paper and one on-screen programming exam. The design of the papers reflects our commitment to clear wording and structure, helping students to tackle each paper with confidence and demonstrate to us what they have learned. Gradual ramping of demand across the papers helps students build confidence.

Paper 01: Principles of Computer Science

This is a written exam paper consisting of five questions, and is marked out of 75. Each question consists of multiple parts, and assesses aspects of a single topic of the subject content. The order in which topics appear varies from paper to paper.

Paper 02: Application of Computational Thinking

This is an on-screen programming exam, and is marked out of 75. Students have two hours in which to carry six programming tasks on a computer using Python 3. They may be required to:

- identify the structural components of a program
- correct errors in a piece of code
- choose between alternative lines of code
- rearrange lines of code
- follow instructions to complete a program.

Tasks increase in complexity, with the final question on the paper requiring students to design and write a program from scratch. There are no questions that require a written response.

Computer Science encourages pupils to create their own games, applications and other systems, rather than simply use those designed by others.



Post 16 Opportunities

This course is an excellent basis for an A Level in Computer Science. This can open the door to a huge number of degrees and apprenticeships. Examples of these are cyber security and big data analytics which are massive areas of growth.

Careers include:

Chemical Process Technician, IT and Computing Teacher, Data Analyst, Designer, Digital Support Technician, Process Controller



Creativity and Designing are at the heart of the new GCSE in Design and Technology.

GCSE Design & Technology

All physical products around us have required people with the skills to design and make them. These items can be anything from a garment to a building or a complex machine.

The course builds upon the areas of the curriculum already studied in school and will involve you learning about the core technical principles in:

- New and emerging technologies
- Energy generation and storage
- Developments in new materials
- Systems approach to designing
- Mechanical devices
- Materials and their working properties.

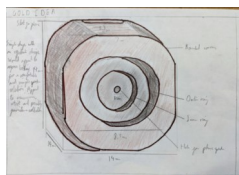
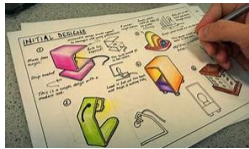

The scope of study in GCSE Design & Technology has broadened considerably to allow opportunities for students to have experience of a wider variety of materials. Although the naming of these areas differs from the titles studied at KS3, they do follow on from Resistant Materials, Systems and Control, Textiles, Graphic Products and CAD/CAM. Specialist areas include:

- *Paper and boards
- *Timber based materials
- *Metal based materials
- *Polymers
- *Textile based materials
- *Electronic and Mechanical systems

The use of Digital skills within Design & Technology is essential and students will enhance their skills in CAD (Computer Aided Design) systems to design and model their work. Using '2D Design' software and 3D CAD modelling using 'Onshape' then leads to laser cutting and 3d Printing. This allows final products to be designed, planned, assembled and tested virtually on screen prior to final production in the workshop.

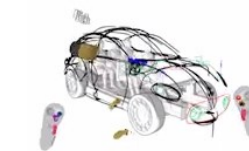

How will I be assessed?

The assessment of this GCSE is split 50% examination at the end of Year 11 and 50% Non-Examined Assessment (coursework) completed between June of Year 10 and the start of the Spring term of Year 11.

For the NEA students will be required to produce their own brief/statement of intent, in response to a given context and then to design and make a product to solve the problem identified. Students will submit a 20 page (A3) portfolio alongside their practical work as evidence of their planning and analysis.

This requires self-direction and dedication to complete work of final GCSE standard throughout a large portion of Year 11.

Post-16 Opportunities

This course is a good stepping stone for students wanting to enter any design orientated careers or degree study where creativity and good problem solving skills are required.

These may include areas such as R & D, Product Design, Architecture, Interior Design, Marketing, Fashion and Engineering.



GCSE Drama

The GCSE Drama specification is designed to give you a broad and balanced experience of Drama. You will be given the opportunity to develop not only your performance skills but also your design skills in areas such as:

- Lighting design
- Sound design
- Set design
- Costume, Hair and Make-Up Design



You will collaborate in devising your own piece of theatre and perform in a performance from a text. You can choose to concentrate on acting or design. You will explore a range of texts and view a variety of live theatre productions.

The Eduqas GCSE Drama specification has three components: Devising Theatre, Performing from a Text, and Interpreting Theatre.

If you enjoy.....

expressing yourself in an active and exciting way, working in a group, contributing your ideas and taking on board those of others, exploring ideas by putting yourself in other people's shoes, playing many parts in different imaginary situations, creating your own drama work, looking at plays written by other people.....

then GCSE Drama is the ideal subject for you.

How will I be assessed?

<p>Component 1: Devising Theatre 40%</p>	<p>You will participate in the creation, development and performance of a piece of devised theatre. You will produce:</p> <ul style="list-style-type: none"> • A portfolio of supporting evidence based on the rehearsal process • A performance lasting between 5-16 minutes (depending on the number of actors in your group) • An evaluation of the final performance or design. 	<p>Teacher assessed, and externally moderated</p>
<p>Component 2: Performing from a Text 20%</p>	<p>You will study two extracts from the same text chosen by you or your teacher. You can choose to be assessed on acting or design. You will produce:</p> <ul style="list-style-type: none"> • A performance lasting between 5-14 minutes using sections of text from both extracts. 	<p>Externally assessed by a visiting examiner</p>
<p>Component 3: Interpreting Theatre 40%</p>	<p>Written examination: 1 hour 30 minutes You will answer:</p> <ul style="list-style-type: none"> • Section A: Set Text - A series of questions based on the set text that you have studied. • Section B: Live Theatre Review – One question from a choice of two, analysing and evaluating a given aspect of a live theatre production seen during the course. 	<p>Externally assessed examination</p>

Post-16 Opportunities

The possibilities are endless. Drama will enable you to demonstrate many skills which employers, colleges and universities will be looking for. It can also give you opportunities to travel, meet people and get the most out of life.

Progress to Higher Education :

Drama and Theatre Studies at AS and A2 Level, BTEC National Performing Arts (Acting).



GCSE English

This is a two year Eduqas course which leads to two GCSE certificates: GCSE English Language and GCSE English Literature.

There are two separate exams within each GCSE, so potentially four exams to complete in the summer of Year 11.

The Language course will include extracts from famous novels, past and present, as well as engaging short stories. In addition, pupils will also encounter a wide range of interesting non-fiction texts.

Pupils' writing will also be developed as they work on creating their own narratives and descriptions, as well as writing articles, letters and speeches for a variety of audiences and purposes.

The Literature course will allow pupils to explore a Shakespeare play, a modern novel or drama, and a set of poems connected by theme.

*I do love nothing
in the world
so much as you...*
William Shakespeare

What sort of books
must I study?

English Language-
extracts/ short
stories from classic
fiction

English Literature-
a Shakespeare
play, a C19th
novel, a modern
novel or play, and a
selection of poems.

WHATEVER SOULS
ARE MADE OF—
His & Mine
ARE THE SAME.
EMILY BRONTE

How will I be assessed?

Q1. Are there different levels of entry?

A1. No. All pupils will be entered for the same exam.

Q2. Are there any controlled assessments to complete?

A2. No. The focus is solely on pupils revising effectively and doing their best in the exams.

Q3. Can pupils take the set texts into the Literature exam?

A3. No. However, examiners don't expect pupils to learn and remember huge swathes of text—a few key quotes will suffice.

Q4. How much oral work is there?

A4. Speaking and listening is an integral part of the course. Pupils will be expected to join in class discussions; to work effectively in a small group; to work with a partner and to perform individual oral assignments.

Speaking and listening will be teacher assessed and reported alongside pupils' GCSE grades but will not carry a percentage of their marks.

Post-16 Opportunities

Teaching, Journalism, Research,
Communications, Publishing,
Television & the Media, Advertising,
Publicity and Public Relations.



"You never really
understand a person
until you consider things
from his point of view—
until you climb into his
skin and walk around in it."
-Harper Lee
"To Kill A Mockingbird"

GCSE Food Preparation & Nutrition

This is a fantastic opportunity to opt for a GCSE, that has been written with the help and input from celebratory chefs and senior dieticians and as such is up-to-date, relevant and exciting.

In year 10 you will cover the knowledge and skills in the following units of work:

- Food preparation skills
- Food, nutrition & health
- Food safety
- Food science
- Food provenance
- Food choice

In Year 11 you will be able to apply all your learning in 2 Non exam assessment tasks:

1. Food investigation task.
2. Food preparation task.



How will I be assessed?

The non exam assessment units completed in Year 11 are worth 50% of the final GCSE grade.

These are carried out during lesson time in controlled conditions; **excellent attendance** is essential in order to complete these assessments. The other 50% comes from a **written examination** in the June of year 11 which tests subject knowledge.

You should consider opting for this GCSE if you:

- Enjoy cooking and **regularly** cook at home.
- May be considering a career within the food industry e.g. chef, food product developer etc.
- Want to combine this knowledge with your science options as the course focuses heavily on the **science of cooking** and how different ingredients and cooking processes produce different outcomes.
- May want to combine this with your PE option because you are interested in **nutrition, diet and health**.
- You are interested in where food comes from, how it is processed and the different ethical, social and environmental reasons people have for the foods they choose to eat.
- You have regular attendance and enjoy the challenge of written and practical project work.

Post-16 Opportunities

This course links in very well for pupils interested in Health and Social Care or PE because of the health and nutritional aspects. It is also fantastic for those wishing to follow the following careers:- dietician, nutritionist, chef, teacher, health & fitness advisor, food technologist and home economist.

It links well with Chemistry. The UK food industry is a growth sector that requires students with a Food Technology and Chemistry background.



"Your Nutrition is your medicine"

Hippocrates
Circa 400 BC



OCR Cambridge National Certificate Level 1/2 in Engineering Programmable Systems

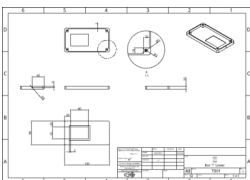
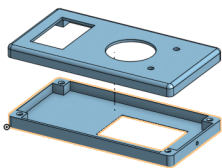
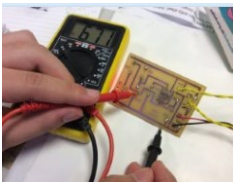
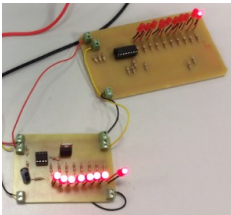
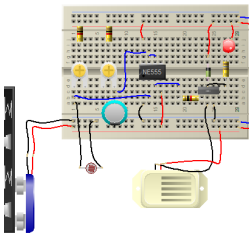
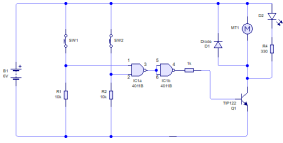

The Cambridge Nationals in Engineering Programmable Systems will develop an understanding of electronic principles, applying these to the manufacture of electronic and electrical circuits, computer controlled devices and microprocessor applications in engineering. You will develop knowledge and understanding of the design, simulation and testing of electronic and microcontroller control systems to consider how a systems design problem is best solved through the use of appropriate components, sensors, transducers and programmable devices.

A theory and practical approach to teaching and learning will provide you with knowledge that underpins the assessment in three units of work with challenges and set tasks to produce a working solution. Investigations in measuring and testing using scientific and mathematical techniques will encourage your critical thinking and apply dextrous skills through engaging practical experiences to produce Printed Circuit Boards that are manufactured and assembled in the Electronics classroom.

You will also gain an understanding of engineering production equipment such as 2D and 3D Computer Aided Design and Manufacture. You will benefit from the links to local industries to see how electronic systems control the production and workflow of factories. Having virtual tours and by having companies give an insight into their manufacturing facilities will give you the experience of a modern factory, and by using our machinery including the laser cutter and 3D printing you will be confident in designing and making parts and assemblies relevant to the future digital skills requirement.

This qualification is open and enjoyed by all pupils who enjoy working with electronic components and are looking to pursue a future in a technical career.

How will I be assessed?

The OCR Level 1/2 Cambridge National Certificate in Engineering Programmable Systems consists of three mandatory units.

Your total mark from the 3 units will result in an award of a Distinction*, Distinction, Merit or Pass at Level 1 or 2.

1. Principles of electronic and programmable systems 40%
2. Making and testing electronic circuits
3. Developing programmable systems

Unit 1 will be assessed through an **externally assessed examination**.

Units 2 and 3 are non examined assessments and are designed to provide you with the opportunity to build a portfolio of evidence to meet the learning outcomes for that unit based on practical and computer involved class assignments.

Post-16 Opportunities

This Certificate will provide knowledge towards a future career in Engineering Systems. This may include studying Level 3 A-Level, a Cambridge Technical or a T-Level at College. It could lead to an Apprenticeship in one of the local Aerospace, Automotive, Civil, Manufacturing Engineering businesses in Lancashire. This would then lead to University and into a highly skilled career which uses electronics and control technology to shape our future world for the better.

OCR Cambridge National Certificate Level 1/2 in Engineering Design

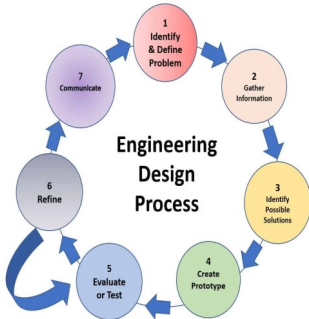

The OCR Level 1/Level 2 Cambridge National in Engineering Design will develop knowledge, understanding and practical skills that would be used in the engineering design and development sector.

You may be interested in this if you want an engaging qualification where you will use what you learn in practical, real-life situations, such as:

- Using both 2D and 3D engineering design techniques
- Designing new products to meet a design brief
- Communicating engineering design ideas.

This will help you develop independence and confidence in using skills that would be relevant to the engineering design and development sector. The qualification will also help you to develop learning and skills that can be used in other life and work situations, such as:

- Completing research to inform engineering design ideas
- Solving problems by exploring different engineering design options
- Finding imaginative solutions through creative thinking.



How will I be assessed?

The OCR Level 1/2 Cambridge National Certificate in Engineering Design consists of three mandatory units.

Your total mark from the 3 units will result in an award of a Distinction*, Distinction, Merit or Pass at Level 1 or 2.

1. Principles of engineering design 40%
2. Communicating designs
3. Design evaluation and modelling

Unit 1 will be assessed through an **externally assessed examination**.

Units 2 and 3 are non examined assessments and are designed to provide you with the opportunity to build a portfolio of evidence to meet the learning outcomes for that unit based on practical and computer involved class assignments.

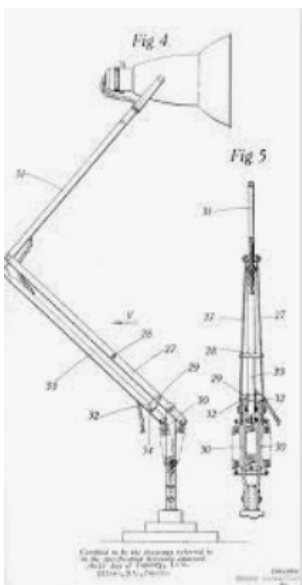

Post-16 Opportunities

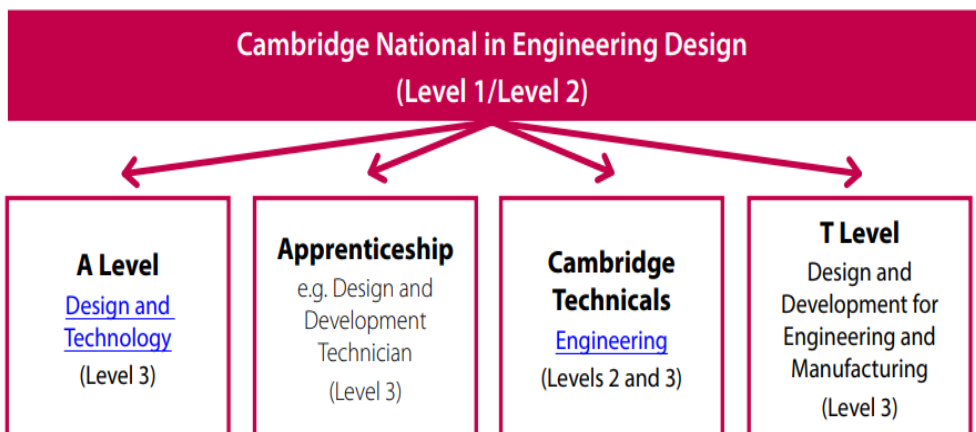

GCSE French

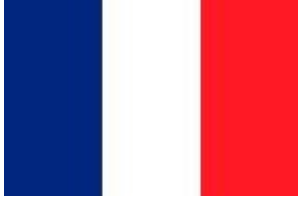

Did you know?

A degree course in languages, either as a main or subsidiary subject will entitle you to spend a year abroad, and not just in France, you could go to Canada or anywhere your chosen language is spoken.

Remember, as a Year 9 student, you have already started the GCSE course and will have completed one third by July!

Languages combine with every occupation e.g. Engineering—is a global profession and you could find yourself working all over the world.

94% of the world's population does not speak English as a first language.

Learning a language boosts your confidence, communication skills and your employability.

Eddie Izzard

“Learning a language is an adventure. It needs work, but it will open up another country to you and you will become a better human being by going on that adventure”

How will I be assessed?

The new GCSE in Modern Languages is assessed through a series of examinations at the very end of the course and across the 4 skill areas: Reading, Writing, Listening and Speaking. These are all equally weighted, each counting for 25% of the final grade. Retrieval skills are quite important but the assessments no longer require you to learn chunks of French, instead they reward for the language you do know and can produce.

You will cover a variety of topics, selected to be relevant and of interest to the lives of young people such as physical appearance, fashion, social media, lifestyle, music and relationships. These will link with other curriculum areas and there will be opportunity to learn more about the culture and traditions of the countries where French is spoken.

At each stage of the course you will know exactly how you are progressing and how to improve. You will develop your skills of translation, become more confident when speaking using your phonics knowledge, give your opinion on issues which interest you and build on the grammar knowledge you acquired in Key Stage 3.

We have many ICT resources and subscription services which will enable you to study independently and develop your skills further.

Post-16 Opportunities

Even if you have no ambition to work abroad, don't forget that Europeans who speak English very well come to the UK and find graduate jobs with international firms because they can operate in more than one language.

In an international job market, these are your competitors too! A language qualification can combine with any other subject you choose to study post-16.



GCSE Geography

Geography at GCSE offers students the opportunity to develop a clearer understanding of our ever changing planet.

Not only do we learn in the classroom, we experience UK fieldwork to the Isle of Arran, the Trough of Bowland and Manchester. We also genuinely explore the world, its places and people, its triumphs and disasters and develop a better understanding of the planet we live on.

In Year 10 we concentrate on physical geography which includes topics such as tropical rainforests, hot deserts, glacial and river landscapes, tectonic and weather hazards and climate change.

Issues studied in Year 11 include the urban world-change and sustainability, the development gap, newly emerging and changing economies and resource and energy management.

How will I be assessed?

Paper 1—**Living with the Physical Environment** (1 hour 30 minutes 35%)

This paper is comprised of structured questions on physical geography.

Paper 2—**Challenges in the Human Environment** (1 hour 30 minutes 35%)

This exam paper is made up of a series of questions on three topics of human geography.

Paper 3—**Geographical Applications** (1 hour 30 minutes 30%) .

In this 1 hour written paper, pre-released resources will test fieldwork skills and techniques.

In order to prepare ourselves for Paper 3, we visit Langden Brook in the Trough of Bowland and Manchester in the autumn term of Year 11.

Pupils also have the opportunity of taking part in a trip to the Isle of Arran in June, which is exclusively for Year 10 geographers.

Much advice and help is given on the methods in collecting, handling and presenting all the information required.

Post-16 Opportunities

Geography is a high performing and thriving subject at St. Augustine's.

With consistently outstanding results and a large proportion of students exceeding their target grade, it is not difficult to see why geography is one of the most popular options at GCSE.

Students who study geography are recognised as being adaptable and familiar with world issues, using techniques of research, planning, communication and presentation that employers demand today.

Many of our students progress to study geography at 'A' Level and on to further studies at university.

The course will be especially relevant to pupils seeking careers in such areas as meteorology, journalism and the media, recreation and tourism, education and environmental management, development, planning, the law and teaching (to name but a few).



Annual Trip to the Isle of Arran



Iceland

All GCSE Geographers participate in local fieldwork in the Trough of Bowland and Manchester as part of the course, and will be offered the opportunity to attend a fieldtrip to the Isle of Arran in Scotland.



Costa Rica Trip
St Augustine's pupils canoeing beneath an active volcano

GCSE Graphic Communication

Graphic Communication is defined as the process of designing primarily visual material to convey information, ideas, meaning and emotions in response to a brief.

Pupils are required to work in one or more areas of Graphic Communication such as:

*Communication Graphics *Design for print *Advertising and branding *Illustration *Package design *Typography *Signage *Exhibition graphics *Techniques

Pupils may explore overlapping areas or a combination of areas. Pupils may use the following **techniques** and processes: typography, illustration, digital and non-digital photography, hand rendered working methods and digital media. Pupils will use media and materials: pencil, pen, ink, pen and wash, crayon and other graphic media, water colour, gouache, acrylic paint, layout materials, digital media, print making and mixed media.

EQUIPMENT: Pupils will need to purchase the following items in Year 10: Sketchbooks A3/A4/A5, A2 portfolio or folder, sketching / shading pencils (full range) and colouring pencils, glue stick, watercolour paints and paintbrushes, oil pastels. Please enquire if need support with this.

Pupils cannot be entered for GCSE Graphic Communication and GCSE Art. It is highly recommended that pupils selecting GCSE Photography do not select Graphics also.



How will I be assessed?

Component 1: Portfolio 60%

This will show coverage of the four assessment objectives. It must include projects and a selection of further work undertaken during the student's course of study.

Component 2: Externally set assignment 40%

Pupils will select a title and then after preparatory time they will have 10 hours of supervised time in which to develop their work.

Pupils will submit all of their work at the end of the two year course digitally and in a portfolio.

Pupils must provide thorough evidence of **drawing** activity in both their portfolio and externally set assignment.

Pupils must provide thorough evidence of **written work** in both their portfolio and externally set assignment.

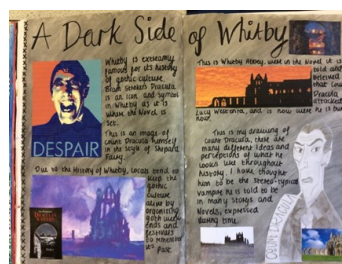

During the course pupils will have opportunities to visit art exhibitions, take part in workshops with artists and develop their ICT skills. There will be an annual visit to Liverpool One and the Liverpool Tate.

Pupils will be required to print some of their own work for a portfolio of photographs. Owning or having access to a digital camera and/or a graphics pad or laptop is beneficial. Please enquire if you need support

Post 16 Opportunities

Graphic Communication is a challenging and very rewarding GCSE subject; it allows pupils to develop excellent research skills and encourages them to communicate their ideas, feelings and experiences through visual outcomes.

Many of our pupils progress through to Fine Art AS and A2 level, Graphics, Photography, Textiles Art & Fashion and other Visual Art courses.

It can also provide excellent groundwork for entry to higher education and degree level careers.

Careers:

Motion Designer, Architectural Designer, Architectural Visualiser, Graphic Designer, Architectural Spatial Designer, Illustrator, Digital/Graphic Designer, Creative Designer (web, graphic, digital), Visual Communication Designer, Multimedia Designer, Art Director.

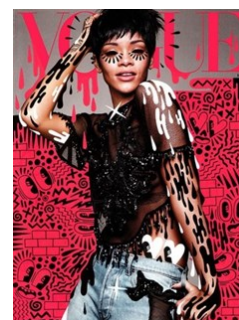

BTEC Tech Award in Health & Social Care

This course is offered to all Year 10 pupils who have an interest in a career within the health, social care or early year's professions e.g. nursing, social work, early years teaching, physiotherapy, occupational therapy, nursery nurse, paramedic etc.

This is an exciting and challenging new course that introduces the pupils to the health and social care sectors. By studying for the Tech award you will gain the important knowledge, understanding and skills that are the foundations for working in this area.

This will include many of the skills that are used by the health care professionals on a day-to-day basis such as assessing peoples health and well being and designing individualised health care plans. You will also learn about health care services and the importance of care values, with the opportunity to apply these to realistic scenarios.

The course is highly valued by local colleges and sixth forms and is a good stepping stone onto the Level 3 course offered in further education.

How will I be assessed?

You will be assessed in two different ways. Components 1 & 2 are assessed through internal controlled assessments. This means that you will receive a set assignment from the examining board. You will then be required to complete each task within a controlled setting and time frame. Component 3 will be assessed via an external assessment in the form of a 2 hour examination within Year 11.

1. Human Lifespan and Development. (Year 10)
2. Health & Social Care Services and Values. (Year 11)
3. Health & Well Being. (Year 10/11)

The Tech Award is equivalent to a GCSE e.g. If a pupil achieves a Level 2 Distinction*, this equates to a Grade 8.5 GCSE. Please see table.

Qualification grading and performance table points

Level	Qualification Grade	2019 performance table points (based on 2018)
Level 2	Distinction*	8.5
	Distinction	7
	Merit	5.5
	Pass	4
Level 1	Distinction	3
	Merit	2
	Pass	1.25

Post-16 Opportunities

It is a course that is highly valued by Colleges of Further Education and is a good stepping stone to further courses offered at local colleges e.g. some past pupils are now paramedics, social workers and early years teachers.



GCSE History

The GCSE History course ranges from 1000AD to present day. It looks at events such as the Battle of Hastings through to the collapse of the Soviet Union's control over Eastern Europe in the 1990s

In Year 10 pupils study the history of crime and punishment in the UK, including an educational visit to Lancaster Castle and studying the infamous Jack the Ripper murders in Whitechapel, London.

In Year 11 pupils study the collapse of the Weimer Republic and the rise to power of Adolf Hitler and the Nazi Party. Following this, we look at the era of the Cold War and The Cuban Missile Crisis.



"Fellow citizens, we cannot escape history". Abraham Lincoln

"History is strewn thick with evidence that a truth is not hard to kill, but a lie, well told, is immortal". Mark Twain

"Never forget the importance of history. To know nothing of what happened before you took your place on earth, is to remain a child for ever and ever". Unknown

How will I be assessed?

Paper 1 – 30%

- Crime & Punishment: 1000AD to present.
- Historical Environment: Whitechapel
- 1870-1900, including Jack the Ripper.

Paper 2 – 40%

- Period Study: Superpower relations and the Cold War.
- British Depth Study: Anglo-Saxon and Norman England.

Paper 3—30%

- Modern Depth Study: Weimar and Nazi Germany.



Post-16 Opportunities

People who study History follow very varied career paths such as:

Archaeology, Teaching, Law, Politics, Journalism, TV & Radio, Archivists, Advertising, Cultural Resources Management, Business Management, Information Management, Historic Preservation, Writers & Editors, Corporate Historians.



OCR Cambridge National in Creative iMedia Level 1/2



The OCR Cambridge Nationals are vocationally-related qualifications that take an engaging, practical and inspiring approach to learning and assessment. They are industry-relevant, geared to key sector requirements and very popular with schools and colleges because they suit such a broad range of learning styles and abilities.

Pupils will have an opportunity to build upon knowledge and skills demonstrated in KS3 to present evidence of their ability in visual identity, multimedia and graphics.



Pupils will have an opportunity to build upon knowledge and skills demonstrated across KS3 to present evidence of their ability in basic business ICT, digital media and web development.

How will I be assessed?

The OCR Level 1/2 Cambridge National Certificate in Creative iMedia consists of three units.

Your total mark from all 3 units will result in an award of a Distinction*, Distinction, Merit or Pass at Level 1 or 2.

1. Mandatory media theory and pre-production external exam (40%).
2. Mandatory digital graphics internal coursework project (25%).
3. Optional internal coursework project on a chosen media theme for the class (35%).

Unit 1 will be assessed through an externally assessed examination.

The other 2 units will be assessed by your teacher and moderated by OCR .



Post-16 Opportunities

Diplomas/Principal Learning
Engineering Levels 1,2 & 3
Apprenticeships Framework
Levels 2 & 3
Cambridge Nationals
In IT Levels 2 & 3

GCE
Electronics, ICT, Applied ICT, Computing-level 3
Engineering, ICT, Computing, Manufacturing-level 1/2

Vocational Qualifications
Creative iMedia, IT Practitioner—level 1 & 2
Employment within the ICT sector and related industries.

GCSE Mathematics

Pupils are tested on their knowledge of: Number, Algebra, Geometry, Measure, Statistics and Probability. A large percentage of the questions will include functional elements which will test the pupils' understanding of the mathematics rather than following 'step by step' methods.

The pupils will follow the Edexcel GCSE Linear Syllabus at the level appropriate to their ability.

At present sets 1-4 study the higher tier and sets 5-8 study the foundation tier. The final decision about tier of entry is generally made after the mock exams in November of Year 11.

Learning of mathematics is enhanced with regular practice and home learning. It may take the form of exercises from text books, worksheets or tasks set online. Where pupils have difficulty accessing the internet, computer access is always available in the Mathematics Department.

Exercise books and text books are used in school in addition to a range of excellent online resources such as MathsWatch, which provides video tuition. Essential equipment needed includes a scientific calculator, a pair of compasses and a protractor.

How will I be assessed?

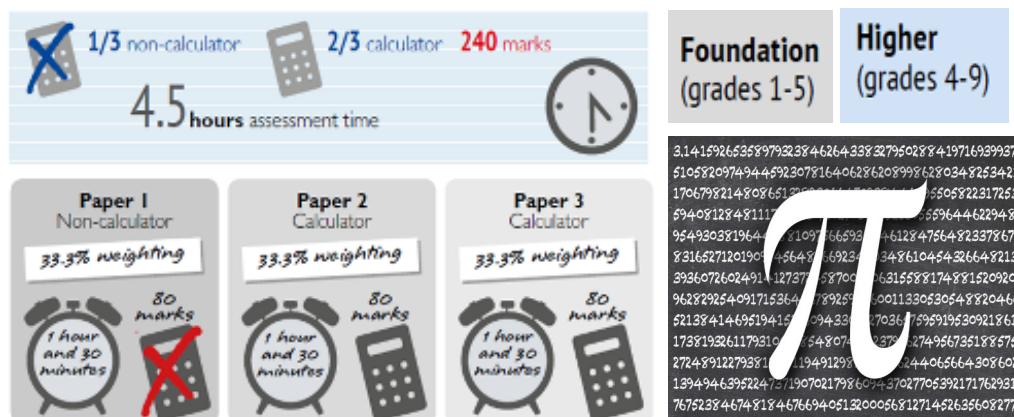

Post-16 Opportunities

A good GCSE grade will allow pupils to access a varied amount of educational courses or provide the qualification required for different career pathways.

For those who wish to continue studying Mathematics a grade 6-9 is recommended to follow AS, A Level and Further Mathematics. Students who successfully complete a university degree or a diploma will have several career prospects open to them such as:

Actuary, Aeronautical Engineer, Chartered Accountant, Corporate investment banker, Financial risk analyst, Meteorologist, Operational researcher, Research scientist (maths), Secondary school teacher, Statistician, Systems developer and many more that may not be specialized mathematical careers.



Galileo Galilei
(1564–1642)

"The universe cannot be read until we have learned the language and become familiar with the characters in which it is written. It is written in mathematical language, and the letters are triangles, circles and other geometrical figures, without which means it is humanly impossible to comprehend a single word. Without these, one is wandering about in a dark labyrinth."



GCSE Music

GCSE Music builds upon the work undertaken in Year 9 and provides an opportunity to gain skills in performing, composing and appraising music.

Throughout the two years there will be many opportunities for the pupils to perform and go on educational visits to musical concerts and recitals.

Q1. Do I need to be a really good musician to take GCSE music?

A1. No, but you do need to enjoy the subject and be prepared to practise at home and improve your knowledge of music theory.

Q2. Do I have to play an instrument?

A2. No, you could sing if you have a suitable voice.

Q3. I don't really want to follow a career in music - is it still worth my taking it at GCSE level?

A3. Very much so. If you are involved in choral, instrumental or keyboard work in the school, you should give it serious consideration.



How will I be assessed?

We follow the **Eduqas** specification.

This specification enables learners to develop knowledge and understanding of music through four areas of study:

1: Musical Forms and Devices 2: Music for Ensemble

3: Film Music 4: Popular Music

For the performance exam the pupil must play either 2 ensemble pieces (in a group of more than 2 live performers) or 1 ensemble and 1 solo piece.

Pupils also undertake 2 composition projects which must be completed in class over the 2 years. These will be based on one of the areas of study.

At the end of the 2 year course all pupils sit a listening exam which tests their knowledge of the 4 areas of study, as well as 2 set works: Badinerie by Bach and Africa by Toto .

Throughout the two years there will be many opportunities for the pupils to perform and go on educational visits to musical concerts and recitals.

Post-16 Opportunities

The course is designed for those who are particularly keen on practical music making, and for those whose music serves as an enjoyable, worthwhile and rewarding hobby rather than a possible career.

However, GCSE music is particularly desirable if the pupil has intentions of taking the subject further.

Possible careers could include: performance, teaching, composing, conducting, concert management, media, music criticism, recording engineering, recording production, music therapy, music librarianship, music publishing, music copying, music retail, music marketing, theatre related work and music agent.



GCSE Photography



Pupils will be required to print some of their own work for a portfolio of photographs.

During the course pupils will have the opportunity to visit photography exhibitions and make visits to sites for photography field trips. There will be a visit to the Clothes Show Live in December to take Fashion Photography.

Owning or having access to a digital camera is essential or a very good phone camera. Please enquire if you need support with this.

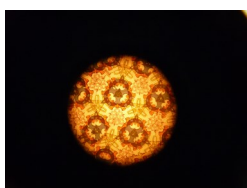

Photography is the practice of producing images using light-sensitive materials such as photographic film, or digital methods of development and production to create static or moving images.

Pupils are required to work in areas of GCSE photography such as:

- *Portraiture
- *Location photography
- *Studio photography
- *Experimental imagery
- *Installation
- *Documentary photography
- *Photo-journalism
- *Moving image: film, video and animation
- *Fashion photography
- *Landscape

Within the context of photography pupils must demonstrate the ability to: Use photographic techniques such as lighting, viewpoint, aperture, depth of field, shutter speed and movement.

EQUIPMENT: DSLR camera (preferable, not essential) or a very good camera phone.

It is highly recommended that pupils who select Photography do not select Art or Graphics also.

How will I be assessed?

Component 1: Portfolio 60%

This will show coverage of the four assessment objectives. It must include a project and a selection of further work undertaken during the student's course of study.

Component 2: Externally set & workshops assignment 40%

Pupils will select a title and then after preparatory time they will have 10 hours of supervised time in which to develop their work.

Pupils will submit all of their work at the end of the two year course digitally and in a portfolio that includes sketchbooks or journals.

Pupils must provide evidence of **DRAWING** activity in both their portfolio and externally set

Pupils must provide evidence of **WRITTEN** work in both their portfolio and externally set task.

Post-16 Opportunities

There are opportunities at various colleges, that we have links to, to further develop your interest in photography by studying the subject at A-Level, where you will get more in depth training in the use of analogue (film-based) and digital photography. Other options include taking a BTEC Level 2/3 Diploma in Creative Media Studies, which is specifically designed to help students progress into the creative industries. Courses in Photography are also offered at London Colleges.

Careers:

Commercial Photographer (Sport, Fashion, Product, Photo Reporter, etc.), Artist, 3D Animator, Web or Graphic Designer, Picture Researcher or Archivist, Image Editor, Art Director, Art Teacher, Photography Director.



GCSE Physical Education

The Edexcel GCSE Physical Education specification follows the new 9-1 syllabus. Practical performance will count for 40% of the marks and the two theory papers will count for the remaining 60%

Q1 Do I have to be good at sport to do GCSE PE?

A1 You will need to be competent in a number of areas, but remember there are a large percentage of marks gained from written work. Moreover, if you think that it will be enough just to rely on your sporting ability, think again.

GCSE PE is an academic subject, requiring a high standard of written work.

Q2 How much PE will I do?

A2 If you choose GCSE PE you will have 5 periods every 2 weeks like any other option subject.. In addition you will also have a weekly 1 hour PE lesson with the rest of the pupils in your year.

Q3 Will I have to do home learning?

A3 YES. Home learning will be a regular feature of the course. It is a physical subject, but a large part of the course includes written work.

Criteria for Acceptance onto the GCSE Physical Education Course.

Good Attendance

Pupils take part in each practical activity for a set amount of weeks.

Good Behaviour & Kit Record

The PE Department want pupils who are trustworthy, reliable and hardworking on the course as safety is always of paramount importance in PE. An excellent kit record at Key Stage 3 is essential.



How will I be assessed?

Practical performance will count for **40 %** of the marks.

Pupils can be assessed on three activities. One must include a team performance e.g. football/netball and one must be an individual performance e.g. athletics. The third activity can be either team or individual. You will be assessed on your skill level and your ability within a competitive situation.

Written examinations will count for **60%** of the marks.

Paper 1—Fitness and Body Systems 1hr 45 mins (36% of qualification)

Paper 2—Health & Performance 1hr 15mins (24% of qualification)



Post-16 Opportunities

The course will naturally lead you on to studying PE at 'A' Level, but it will also be useful if you wish to take courses in Leisure and Tourism or Sports Sciences.

The leisure industry remains one of the fastest growing areas in the job market. GCSE PE will equip you with skills needed in this industry. It will also be helpful if you wish to follow a career as a sports coach, a PE teacher or a physiotherapist.



GCSE Religious Education



All pupils follow a GCSE course in Religious Studies, Edexcel Pearson Specification A.

The GCSE consists of a study of Catholic Christianity and Judaism.

Q. How will Religious Studies help me ?

Your Religious Studies Course will help you with your own faith and understanding of the Catholic Church, but also you will further develop your knowledge of other faiths and develop some important exam skills.

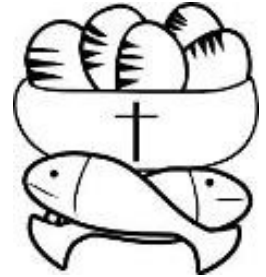

'Do not let people disregard you because you are young, but be an example... in the way you speak and behave and in your love, your faith and purity.'

1 Timothy 4:12

How will I be assessed?

At the end of each unit pupils will complete a short test to keep track of progress through Year 10 and 11.

Pupils are encouraged to aim high to attain the highest grades, regardless of the set they are in.

The course will be examined with 3 papers at the end of Year 11.



Post-16 Opportunities

Employers and colleges welcome students who have achieved a good GCSE grade. 'A' Level Religious Studies is a popular option.

The RE GCSE can enhance the development of analytical skills and provides an excellent grounding for the study of A-Levels such as Theology, Religious Studies, Philosophy, Criminology, Sociology, Psychology, History, Law, and Media. This in turn opens pathways to many careers including Teaching, Nursing, Medicine and Law.



Science

All pupils will study science for a minimum of 20% of curriculum time. However there are two pathways our pupils can take to enable them to achieve their potential.

As Science is compulsory at Key Stage 4, in some cases we will choose the pathway best suited to your child.

Our decision will be made in the best interests of your child in helping them to achieve the highest grade they can, ensuring that post 16 opportunities are left open.

Pupils who wish to study Triple Science (Biology, Chemistry and Physics) will need to choose Triple Science on the Option form.

This will take up one option. The remainder of the course will be taught in core science time.



Science is about the world we live in and the organisms which live in it. Scientists ask questions, make observations and carry out investigations in order to solve problems.

Combined Science

The majority of pupils will study GCSE Combined Science in Years 10 and 11 which is a double award leading to 2 GCSEs.

All examinations will be taken at the end of Year 11. There is no controlled assessment, however there are 21 compulsory practicals which must be completed over Years 10 and 11. These will be assessed in the final examinations.

This specification content consists of one third Biology, one third Chemistry and one third Physics. Each of these subjects is worth one third of the final examination mark.

Pupils will study science for 5 lessons per week.

Pupils will be awarded two grades e.g. 8-7, 7-7, 7-6 etc

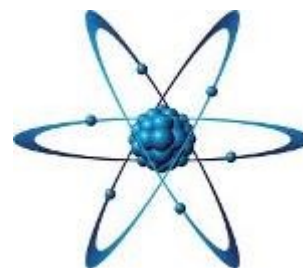

Triple Science

There is the opportunity for some students to study the three separate sciences, biology, chemistry and physics. Two subjects will be studied in core science time and one as an option subject.

This option is recommended for pupils who are intending to study science at 'A' level or beyond. This course will lead to 3 separate GCSE grades in biology, chemistry and physics. All three separate sciences must be studied to fulfill the requirements of the National Curriculum.

All subject content will be examined at the end of Year 11. There is no controlled assessment, however there are a number of compulsory practicals to be completed in Years 10 and 11. These will be assessed in the final examinations.

Pupils will study each of the sciences for 5 periods per fortnight. Due to the demand of the increased content, it is recommended that each pupil has a GCSE target of grade 5 or above.

The process of science is a way of building knowledge about the universe, constructing new ideas that illuminate the world around us.



Post-16 Opportunities

Pupils who wish to study sciences at 'A' Level will need at least a grade 6 in the chosen science plus one other science at grade 6 or above. Grade 6 Mathematics is also needed.

Pupils studying Combined Science will need a grade 6 in both subjects if they wish to do a Science 'A' Level.





GCSE Spanish



Did you know?

A degree course in languages, either as a main or subsidiary subject will entitle you to spend a year abroad, and not just in Spain, you could go to Central and South America, the Caribbean or anywhere your chosen language is spoken.

Remember, as a Year 9 student, you have already started the GCSE course and will have completed a third by July !

Languages combine with every occupation e.g. Engineering—is a global profession and you could find yourself working all over the world.

94% of the world's population does not speak English as a first language.

Learning a language boosts your confidence, communication skills and your employability.

How will I be assessed?

Eddie Izzard

“Learning a language is an adventure. It needs work, but will open up another country to you and you will become a better human being by going on that adventure”.



The new GCSE in Modern Languages is assessed through a series of examinations at the very end of the course and across the 4 skill areas: Reading, Writing, Listening and Speaking. These are all equally weighted, each counting for 25% of the final grade. Retrieval skills are quite important but the assessments no longer require you to learn chunks of Spanish, instead they reward for the language you do know and can produce.

You will cover a variety of topics, selected to be relevant and of interest to the lives of young people such as physical appearance, fashion, social media, lifestyle, music and relationships. These will link with other curriculum areas and there will be opportunity to learn more about the culture and traditions of the countries where Spanish is spoken.

At each stage of the course you will know exactly how you are progressing and how to improve. You will develop your skills of translation, become more confident when speaking using your phonics knowledge, give your opinion on issues which interest you and build on the grammar knowledge you acquired in Key Stage 3.

We have many ICT resources and subscription services which will enable you to study independently and develop your skills further.

Post-16 Opportunities

Even if you have no ambition to work abroad, don't forget that Europeans who speak English very well come to the UK and find graduate jobs with international firms because they can operate in more than one language. In an international job market, these are your competitors too! A language qualification can combine with any other subject you choose to study post-16.



OCR Cambridge Nationals in Sports Studies Level 1/2

The OCR Level 1/Level 2 Cambridge National in Sport Studies will develop knowledge, understanding and practical skills that can be used in the Exercise, Physical Activity, Sport and Health sector. This course is ideal if you want an engaging qualification where you will use your learning in practical, real-life situations, such as:

- Understanding contemporary issues in sport and how they impact on different sporting activities
- Applying your skills as both a performer in two different sporting activities and as a leader in one sporting activity
- How to be a sports leader, through using your initiative to solve problems and making decisions when dealing with rapidly changing conditions and situations
- Understanding the relationship between sport and the media and applying this to real life examples
- How to evaluate and interpret the different ways in which sport is represented by the media.

Frequently asked questions

Q1 Do I have to be good at sport to do this course? A1 You won't be assessed on your outright ability, but you will assess how to improve your performance and that of others. You will also officiate games and plan to improve levels of skill.

Q2 How much PE/sport will I do? A2 If you chose Cambridge Nationals in Sports Studies you will have 5 periods of PE over 2 weeks like all other subjects. You will also have a weekly 1 hour core PE lesson with all other students in your year.

Q3 Will I have to do home learning? A3 Yes! Home learning is a feature of the course. It is largely a practical subject but includes sections of written work.

To be accepted onto the course, students must have **good attendance**. Missing large sections of the course will have a negative impact on attainment. Students must also have a **good behaviour record** and an **excellent kit record**. Students must be hard working, reliable and must also be prepared to volunteer at events/games. This subject requires a good standard of written work and an application to practical tasks.

How will I be assessed?

Students will study two mandatory units and one optional unit from a choice of two.

The two mandatory units are:

- **R184: Contemporary issues in sport** - This is assessed by an exam and worth 40% of the course. By completing this unit you will understand a range of topical and contemporary issues in sport, including learning about participation levels and barriers to completing sporting activities. You will also learn how participation is impacted by the promotion of values and ethical behaviour, about the role of high-profile sporting events, the role of national governing bodies and how technology is used in within sport.

- **R185: Performance and leadership in sports activities** - This is assessed by a set assignment. In this unit you will have an opportunity to develop your skills both as a performer in two different sporting activities, and as a leader, developing a range of transferable skills. You will work both independently and as part of a team, including communicating with team mates as well as being in front of an audience when you perform. You will perform under pressure, both as a participant and as a leader, and will use your initiative to solve problems and make decisions. Finally, you will deal with rapidly changing conditions and situations.

The optional unit is

R186: Sports and the media - This is assessed by a set assignment In this unit you will understand the different sides of a range of media sources and apply real life examples to show the nature of the relationship between media and sport. You will also learn how rapid development in technology is enabling sport to be viewed, replayed and discussed whenever and wherever the spectator wants. You will then develop your ability to evaluate and interpret the different ways in which

Post-16 Opportunities

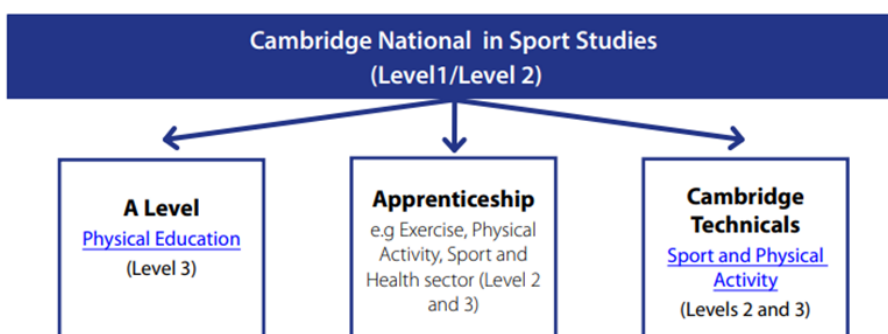

ASDAN Personal Development

The flexibility of ASDAN's Personal Development Programme means they can be carried out in a variety of settings, over a time period to suit the individual . Challenge descriptions can be interpreted and adapted according to the situation.

- Flexible, multi-level program
- Internally moderated
- Courses build credits towards a Personal Development Programme

Possible courses may include:

- Communication
- Work Place
- Enterprise
- Learning Skills
- ICT
- Health



How will I be assessed?

Learners must present evidence of their activities in an organised portfolio or e-portfolio. This will contain:

- a record of challenges completed, with supporting evidence for each challenge
- recording documents, showing how learners have planned and reviewed their activities
- summary of achievement, highlighting skills development
- personal statement

Post-16 Opportunities

- Offers progression to AoPE and Wider Key Skills
- BTEC / Vocational Level 2 courses



This course can only be selected after contacting Mrs Day / Mr Earnshaw - Curriculum Leader, Learning Support

POST 16 PROVIDERS - GENERAL ENTRY REQUIREMENTS

This is a guide only and colleges may change their entry requirements for individual cases so we strongly recommend you contact the colleges.

A Levels

Blackburn College	At least 5 GCSEs at grade 4
Burnley College	At least 5 GCSEs at grade 5 to study 3 A Levels At least 5 GCSEs at grade 6 to study 4 A Levels
Cardinal Newman College	At least 5 GCSEs at grade 5
Clitheroe Grammar School	At least 4 GCSEs at grade 6

Please note that certain subjects will have specific entry requirements.

Level 3 Vocational Courses

Blackburn College	5 GCSEs at grade 4
Burnley College	5 GCSEs at grade 5

Level 2 Vocational Courses

Blackburn College	GCSEs at grade 3
Burnley College	A minimum of 2 GCSEs at grade 5

Level 1 Vocational Courses

Blackburn College	3 GCSEs at grade 2
Burnley College	A minimum of 2 GCSEs at grade 3

T Levels

Burnley College	At least 5 GCSEs at grade 6
Cardinal Newman College	5 GCSEs at grade 5

Monitoring Performance at KS4

Monitoring

Pupils in Years 10 and 11 have their work monitored in terms of their effort and attitude to learning at regular intervals. This information is sent home in the form of a 'KS4 Monitoring' report.

Pupils not achieving acceptable standards of work will be followed up by Class Teachers, Curriculum Leaders or Year Leaders and given targets to improve.

Your support and encouragement will also have a vital part to play in your child's success.

Progress Tracking

Parents and carers will also be informed of their child's progress in each subject area via a 'KS4 Progress Tracking' report.

Options Form 2024

Electronic MS Form Distributed After Progress Evening

Name:	Form:
--------------	--------------

A <i>Choose 1 subject</i>	B <i>Choose 2 subjects</i>
GCSE Computer Science	*GCSE Art
GCSE French	GCSE Computer Science
GCSE Geography	*GCSE Design & Technology
GCSE History	GCSE Drama
Cambridge Nationals Creative iMedia	Cambridge Nationals Engineering Programmable Systems
GCSE Triple Science	*Cambridge Nationals in Engineering Design
GCSE Spanish	GCSE Food & Nutrition
*Learning Support	GCSE Geography
	*GCSE Graphics
	BTEC Health & Social Care
	GCSE History
	Cambridge Nationals Creative iMedia
	GCSE Music
	GCSE Photography
	*GCSE Physical Education
	GCSE Triple Science
	*Cambridge Nationals Sports Studies
	*Learning Support
1st Choice:	1st Choice:
	2nd Choice:

Reserve Choice from A or B:

*Notes

Pupils should choose 1 subject from column A and 2 subjects from column B, together with a reserve subject from column A or B.

Owing to the overlap in subject content, pupils cannot study both GCSE Art and GCSE Graphics. Similarly pupils will not be able to study GCSE PE as well as the Cambridge Nationals in Sports Studies course.

We would recommend that GCSE Design & Technology and Cambridge Nationals Engineering Design are not taken together and both may not be offered based on numbers choosing them.

Learning Support/can only be chosen in special circumstances, if recommended by Mr Earnshaw.